

# GA500

AC Microdrives for Industrial Applications



# GA500 - Balancing power to perfection

Cost-savings through  
optimized application Efficiency

Experience from 30 million  
installed AC drives

Application Reliability with 10 years  
of maintenance-free drive operation

Flexibility to master any challenge

Maximized machine Performance

Ease of use minimizes setup times



Drawing upon more than 100 years of experience in driving motors, Yaskawa develops products which perfectly combine technical superiority with easy operation.

The latest result of this evolution is the new GA500 microdrive. Compact in size and flexible in terms of motor type and connectivity, the GA500 is designed to easily master nearly any application.

#### **Simplified system integration**

GA500 drives are designed to be easily integrated into systems and machinery. Combining network support, application-focused features, and excellent customization options along with unparalleled ease of use, the GA500 minimizes the effort required to get your automation jobs done.

#### **Fast installation and setup**

GA500 drives incorporate a variety of features which eliminate the need for peripherals. Together with easy wiring plus smart functions for completing a basic setup in only in 5 minutes, this greatly reduces the time and expenses involved in having a running system.

#### **Superior machine performance**

By incorporating the latest motor control technologies for induction, permanent magnet, and synchronous reluctance motors, the GA500 drives provide superior control performance with minimized energy consumption.

#### **Secure operation**

GA500 drives are built to perform reliably. The robust design featuring coated PCBs allows operation in 50 °C without derating, while machine monitoring functions and an integrated service life time prediction prevent sudden failures. The GA500 thus effectively secures operation and prevents production losses.



GA500 – flexibility, ease of use, and a sustainable design offer the best value proposition for your application.

# Makes life easier

The GA500 drive comes with value-adding functions and smart features which offer benefits throughout the entire life cycle of a machine or installation. No matter if it is drive selection, through design, installation, start up or troubleshooting, the GA500 makes life easy.

## Temperature controlled fans

Cooling fans run only when needed. Contamination is minimized while service intervals can be prolonged.

## Tactile keypad

The bright LED display and tactile buttons make menu navigation easy and intuitive. The removable keypad can serve as a parameter backup or copy unit.

## Robust design

The GA500 can be operated at altitudes of up to 4000 m and in high-temperature environments of up to 60°C. Coated PCBs protect the drive against dust and mist.

## Embedded braking chopper

Handle regenerative energy with a minimal number of external parts.

## Scalable

Embedded programming environment for customizing drive functions can replace external controllers.

## 24 VDC power input for controller

Simplify your wiring and keep your control system operational, even during standby or power outages.



## Common menus

Menus and parameters are arranged and named as with any other YASKAWA drive, thus reducing training expenses.

## USB port

Easily connect to your PC or mobile device for programming, monitoring or troubleshooting the GA500.

## Minimal service requirements

10-year maintenance-free design provides hassle-free long term operation.

## Screwless control terminals

Easily create long-lasting, reliable connections without the need for re-tightening.

## Easily accessible main circuit terminals

Connect main circuit and motor cables in shortest time without removing any covers.

## 24 VDC power for sensors

Internal power supply delivers an extra 150 mA for use with external sensors, thus eliminating the need for a separate power supply.

## Built-in EMC filter

Easy compliance with global standards and simplified machine design due to a reduced number of parts.

## Optimal rating

Normal Duty rating allows operation of a motor that is one size larger in variable torque applications.

## Production security

Service life indicators for main components prevent production losses due to sudden breakdowns.





### Programming without power

The GA500 can be programmed without any power supply connected, even while the drive is still in the box. Simply connect to a PC USB port or any USB on-the-go device, start programming, and enjoy the easy commissioning.

### Optional LCD keypad:

#### Additional functionality

GA500 drives can be programmed and operated with an external high-resolution graphical keypad. Support for 13 languages, a Setup Wizard, and the intuitive full text menu structure simplify drive setup and save valuable time.

- Copy function for 4 sets of parameters
- Data logging on Micro-SD card
- Real-time clock
- Available with Bluetooth for connecting a mobile device
- Automatic backup function
- Standard RJ45 cable connection

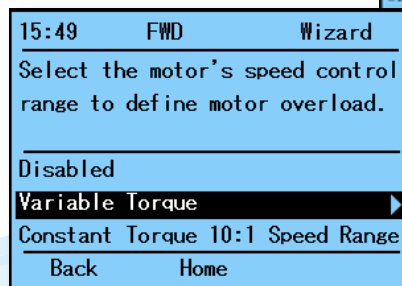
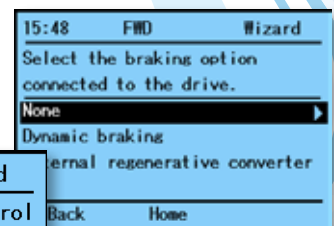
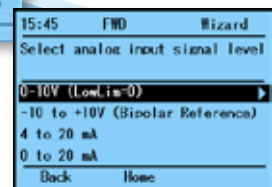

### Setup wizard

The Setup Wizard reduces the setup time to just a couple of minutes. It guides the user through the basic setup using simple questions which do not require any knowledge of drive parameters, thus saving valuable time.

# Effortless network integration

GA500 drives support all the major industrial communications and connection topologies for adaptation to a variety of factory automation networks. Tested and verified function blocks allow fast and hassle-free network implementation.

## Embedded +24 VDC input

When powering the GA500 through the built-in 24 VDC control power input, network communication can be maintained even during main power loss, thus enabling continuous monitoring and faster startup on power recovery.



## Cost effective network integration

Up to five GA500 drives can be accessed through just one fieldbus option card, thus providing a cost effective solution with less wiring effort.

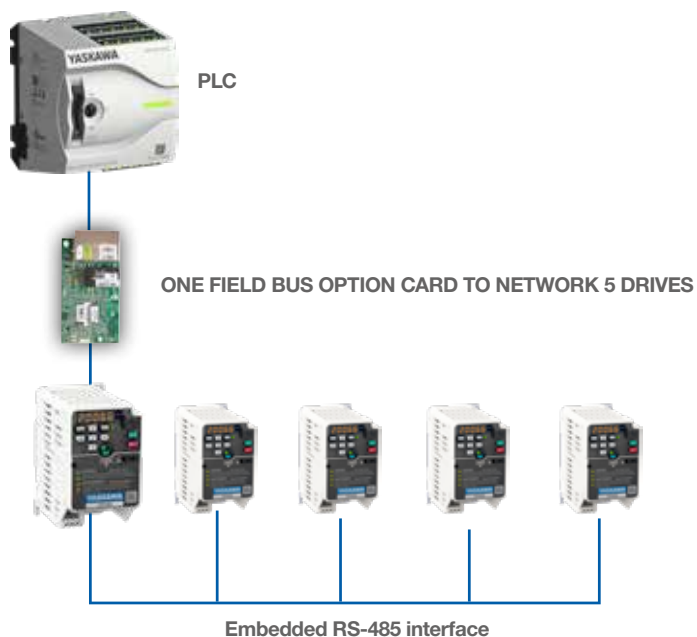

## Easy integration into your network

- Supports all major networks and topologies

## Cost savings with built-in protocols

- RS-485 MEMOBUS/Modbus protocol
- 115.2 kbit/s communication speeds

DeviceNet™

CC-Link

ETHERNET POWERLINK

CANopen

MECHATROLINK

PROFIBUS

EtherNet/IP™

PROFINET

EtherCAT®

Modbus

# One for all

The GA500 precisely controls induction, permanent magnet, and synchronous reluctance motors, providing the versatility to run a variety of applications with just one drive. With the new EZ Vector mode, the GA500 can run all of these motor types without the need for extensive tuning.

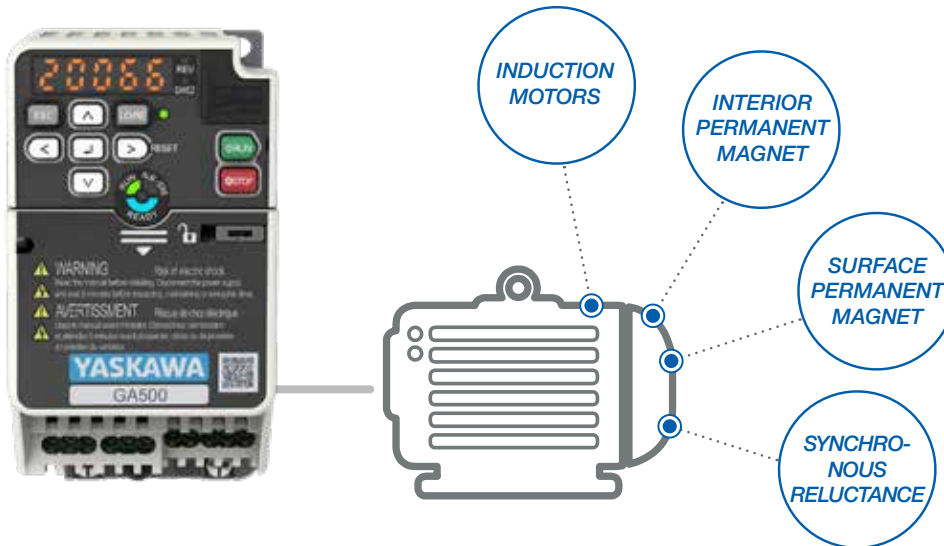

## One drive for various applications

- Open loop zero speed and torque control of permanent magnet motors
- Run induction, permanent magnet, and synchronous reluctance motors with only one type of drive
- 590 Hz output frequency
- High switching frequency for silent motor operation
- Time-saving and hassle-free setup of any motor without the need for Auto-Tuning

# Energy efficient

By reducing conversion losses to a minimum the GA500 operates with an outstanding efficiency of up to 98.5%. In addition, the sophisticated motor control operates motors at their maximum efficiency in industrial applications ranging from simple fans or pumps to compressors, conveyors and a lot more.

## Best performance

Minimum operation cost

Small carbon footprint

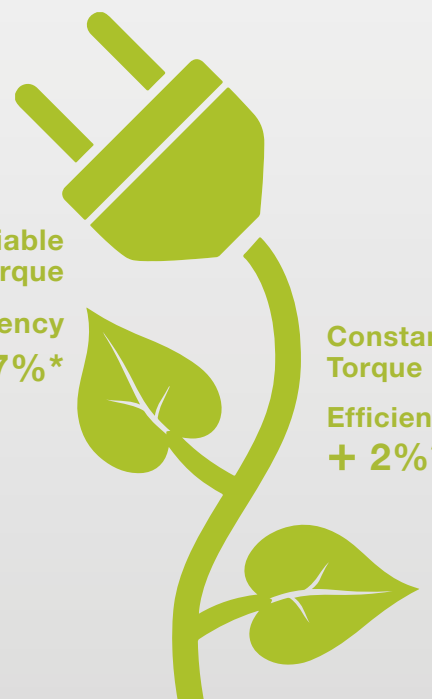
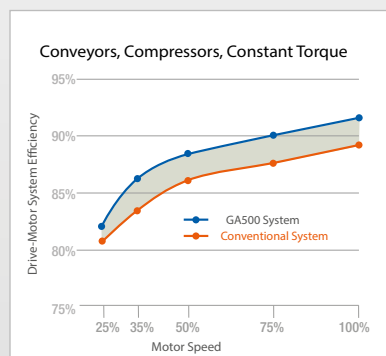
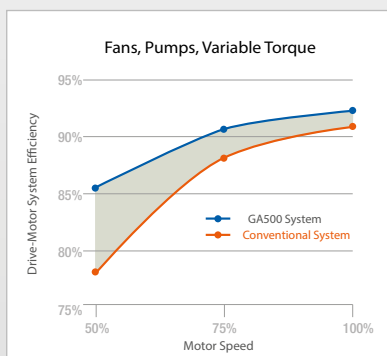

GA500 drives provide enormous potential for energy saving by operating your applications at best efficiency.

\* Comparison of conventional drive with Permanent Magnet motor and GA500 with the same motor

# Easy engineering and customization

The GA500 drive comes with powerful yet intuitive engineering tools that help minimize setup time while also offering great potential for simplification of machinery and installations.

## DriveWizard® 10

DriveWizard® 10 enables easy configuration of GA500 drives. Its comprehensive monitoring functions and integrated oscilloscope allow easy process optimization and fast troubleshooting.

- Connect to the GA500 via USB – even without mains power!
- Configure the GA500 online or offline.
- Log your process with up to six channels of recorded data.
- Create reports to export and send via email.
- Simplify operation and save valuable time during setup, maintenance, or troubleshooting.
- Import and export data with DriveWizard mobile.
- Connect to multiple drives though ProfiNet, EtherNet/IP or Modbus TCP.



## DriveWorksEZ® 10

DriveWorksEZ® is an icon-based, drag-and-drop graphical environment for adding programmable functions allowing the drive to be tailored for a variety of machine and application requirements without the cost of external controllers, such as PLCs or additional controller hardware options.

- Select from 400+ function blocks
- Logic/math functions
- Timers/counters
- Up to 100 connections
- Offline simulation mode for testing without the risk of application malfunctions
- Protection of intellectual property with project lock
- Online monitor for visual debugging
- Fast cycle time of 2 ms, independent of program size

### DriveWorks Application Library

The DWEZ Application Library provides pre-configured applications that can be used instantly or can be modified and expanded to fit the need of your application or machine.

These are just a few of the applications available:

- Brake sequence
- Flexible timer
- Torque limits
- Master-Slave via serial communication without PLC
- Dual PI controller
- Unbalance detection





# Always handy

Everything needed to operate a GA500 fits right in your pocket. The DriveWizard® mobile and the Manuals App turn your smart-phone or tablet into a versatile and indispensable toolbox for GA500 drives.

## DriveWizard Mobile

DriveWizard mobile is the ultimate setup tool for GA500 drives. From simple parameter editing to the Setup Wizard with an 8 channel fully featured oscilloscope, it provides all the tools needed for setup, monitoring, and process optimization.

- Intuitive parameter editing with help and search functions
- Create favorite parameter lists
- 8-channel oscilloscope with comprehensive trigger functions and data analysis
- Parameter backup/verify
- Setup Wizard for quick setup without knowledge of menus and parameters
- Troubleshooting support with fault analysis and countermeasures
- Export to DriveWizard PC tool
- Worry-free data recovery: Parameter back-up/retrieval anytime via Yaskawa cloud service for registered drives
- Usable offline in areas without mobile reception



Mobile device connectivity is enabled using the built-in USB port (USB on-the-go) or via wireless communication with the Bluetooth® LCD keypad option.

Bluetooth® and the Bluetooth logo are registered trademarks of Bluetooth SIG, Inc. USA. Android™ is a trademark of Google Inc. iOS® is a registered trademark of Apple, Inc. and is used under license by Apple, Inc.

## Yaskawa Manuals App

Never carry heavy paper manuals again. With the Yaskawa Manuals App latest manuals for GA500 drives are always close at hand on your phone.

- Responsive layout – line breaks automatically adjust to zoom level for optimal readability without panning left/right
- Quickly find the information you really need using the search function
- Set your own bookmarks for frequently used pages
- All books can be downloaded for offline use
- Documents are always up-to-date



Search for

**YASKAWA**

on



# Flexible installation solutions

Regardless of whether you put the drive in a control cabinet, on a wall, in a clean environment, or in a harsh one, the flexible package design of the GA500 enables a reliable operation under a variety of environmental conditions.

## External heatsink mounting

With the optional ring kit the GA500 can easily be installed with the heatsink outside the cabinet. By this, in many cases 77 % of the heat loss is moved outside the panel thus allowing for smaller panels, reduced panel cooling or for more equipment in the same panel.

Reduced air flow inside the panel additionally contributes to lower contamination by dust and prolongs service intervals.

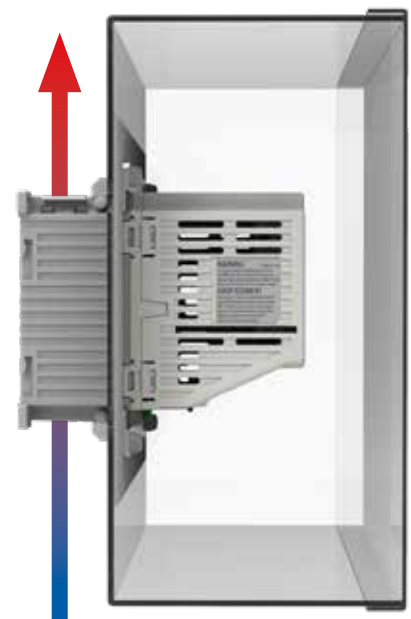

*External heatsink mounting*

## Finless drives

The GA500 Finless type is made to be mounted on external heat sinks, water coolers or any other type of heat spreader. This great flexibility widens freedom for machine designers and provides ways for perfect integration with a variety of machine cooling concepts.



*Liquid cooling system*



*External heatsink*



*Flat backplate*

## Side-by-Side mounting

The GA500 can be mounted side-by-side with bottom entry wiring to reduce cabinet size.

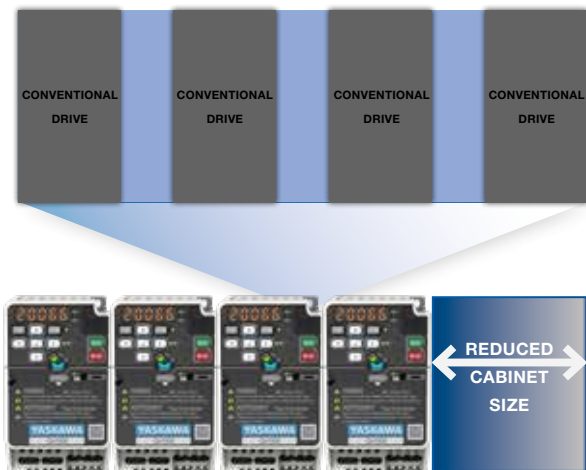

## Built-in options

The GA500 is available both with and without an embedded EMC filter. Both versions share the same footprint and differ only in depth.



## DIN rail mounting

GA500 drives up to 4 kW can simply be snapped onto a DIN rail using an optional attachment, thus saving valuable time during installation.



## UL Type 1 kit

For installations that require UL type 1 compliance, the GA500 can simply be upgraded with a mechanical kit.



UL Type 1 kit

# High speed applications

## Up to 2000 Hz output frequency

With a maximum output frequency of up to 590 Hz, the GA500 covers a wide range of applications. Should higher speeds be required, the output frequency range can be extended up to 2000 Hz. This, coupled with high over-torque capability and full fieldbus controllability, makes the GA500 an excellent choice for spindle applications in metal or woodworking, but also for centrifuges and other high-speed applications.



# Rugged

Designed for 10 years of maintenance-free operation, the GA500 is built tough to withstand even harsh and demanding conditions.



### Coated board protection

Coated PCBs as standard protect the electronics from dust or humidity while ensuring reliable operation even in harsh environments (IEC 60723-3-3, 3C2, 3S2).

### Wide ambient temperature range

GA500 drives can be safely operated in ambient temperatures ranging from -10 up to 60°C. Up to 50°C, the drives do not even have to be derated and full power can be drawn.

### Vibration resistant

GA500 drives can be supplied with an option for higher vibration resistance. With this the benefits of GA500 can be utilized even in mobile or other applications with high occurrence of vibration without sacrificing reliability.

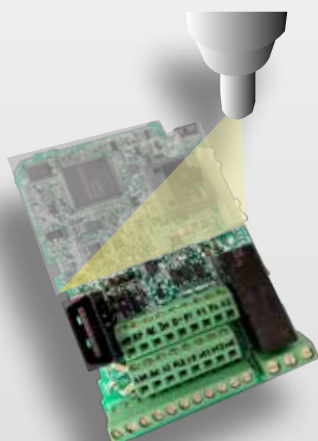



# Predictive maintenance

## Drive self diagnosis

The GA500 constantly monitors wear and tear of its main components. Should a component reach its predicted life time, an alarm is set and replacement can be prepared and installed ahead of a break down. Sudden process stop is prevented and production is secured.



## Machine failure prevention

The GA500 can be utilized for sensing the condition of a machine or application. By evaluating signals such as voltage, torque, current, it can detect abnormal conditions like clogged filters, lack of lubrication and others. An alarm is set in time preventing sudden break down and production loss.



# Safe

## Integrated functional safety

With the built-in dual channel STO (safe torque off, SIL3/PLe), the GA500 provides the right tools for easy machine integration of emergency stop functions, even when elevated levels of risk reduction are required.

TÜV Certified

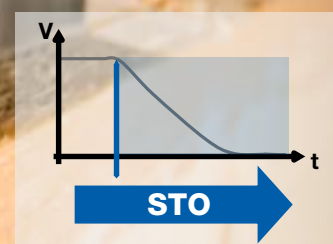

# Specification overview

## Motor control

<b>Motor types</b>	Induction Motor (IM), Permanent Magnet Motor (IPM/SPM), Synchronous Reluctance Motor (SynRM)
<b>Control methods</b>	Sensorless V/f and Vector control, EZVector
<b>Torque control</b>	For IPM motors without encoder
<b>Zero speed</b>	For IPM motors without encoder
<b>Motor parameter tuning</b>	Automatic, rotating/static

## Further functions

Integrated PID controller with sleep function
Automatic main power loss ride through
Speed Search function for smooth start of coasting motors
Braking with over-magnetization for fast stop without braking resistors
Energy-saving function
Automatic restart after failure
Overvoltage suppression

## Protective functions

Stall prevention, overload prevention, overheat prevention and further protective functions for the motor, the application and the AC drive
---

## Self-monitoring

Monitoring of main components (fans, IGBTs, capacitors, charging circuit) with maintenance alarm notification
---

## Communication options

Communication options	Model code
CANopen	SI-S3
CC-Link	SI-C3
DeviceNet	SI-N3
EtherCAT	SI-ES3
Ethernet/IP / Dual-Port	SI-EN3 / SI-EN3/D
MECHATROLINK-III	SI-ET3
Modbus/TCP / Dual-Port	SI-EM3 / SI-EM3/D
POWERLINK	SI-EL3
PROFIBUS-DP	SI-P3
PROFINET	SI-EP3
Communication Option Case (required when using a communication option)	JOHB-GA50

## Other options

Bluetooth® keypad, attachment for external heatsink, external EMC filter, shield clamp kit, AC chokes, harmonics filter, output chokes, braking resistors, braking modules, DIN rail attachment, UL-Type 1 Kit, cable shield kits, low leakage filter
---

## Operating environment

<b>Ambient temperature</b>	IP20: -10 to +50 °C/+60 °C with derating UL Type 1: -10 to +40 °C/+50 °C with derating Finless: -10 to +35 °C/+60 °C with derating
<b>Storage temperature</b>	-20 to +70 °C
<b>Humidity</b>	95 % RH or less (non-condensing)
<b>Altitude</b>	Up to 1000 m without derating, up to 4000 m with derating
<b>Vibration/Shock</b>	10 to 20 Hz: 9.8 m/s <sup>2</sup> 20 to 55 Hz: 5.9 m/s <sup>2</sup>
<b>Protection design</b>	IP20 standard, UL Type 1-Kit (optional)
<b>Mounting</b>	Side-by-side, DIN rail, external heatsink
<b>Environmental conditions</b>	IEC 60721-3-3, Class 3C2 (chemical gases), Class 3S2 (solid particles)

## Conformity / Standards

<b>Standards</b>	CE, UL, cUL, EAC, REACH, RoHS
<b>Functional safety</b>	IEC/EN61508 SIL3 (STO), PLe

## Power ratings

<b>Overload capacity</b>	150 %/1 min. (heavy duty) or 110 %/1 min. (normal duty)
<b>Rated voltage</b>	200 to 240 VAC, -15 to +10 % 380 to 480 VAC, -15 to +10 %
<b>Capacity range (ND)</b>	200V Class, 1-phase: 0.1 to 3.7 kW 200V Class: 0.1 to 22 kW 400V Class: 0.2 to 30 kW
<b>Output frequency</b>	0 to 590 Hz; up to 1000 Hz (PM motor) and 2000 Hz (IM motor) optional
<b>Carrier frequency</b>	8 kHz (HD) or 2 kHz (ND); max. 15 kHz
<b>Braking transistors</b>	Integrated

## Control / Programming

<b>Control inputs</b>	7 digital, 2 analog (1×V/I, 1×V), 1 pulse
<b>Control outputs</b>	1 relay, 2 photo coupler, 1 pulse, 1 analog
<b>Virtual input/output</b>	For connection of I/O functions without physical wiring Multiple assignment of I/O functions for easier wiring
<b>Programming interface</b>	Mini-USB on the front cover; digital operator with Bluetooth® (optional)
<b>Keypad</b>	7-segment LED with 5 digits, tactile soft buttons
<b>Serial communication</b>	Memobus/Modbus, RS-485, up to 115 kbit/s

# Connection diagram

Single-phase  
200 V  
power supply,  
50/60 Hz

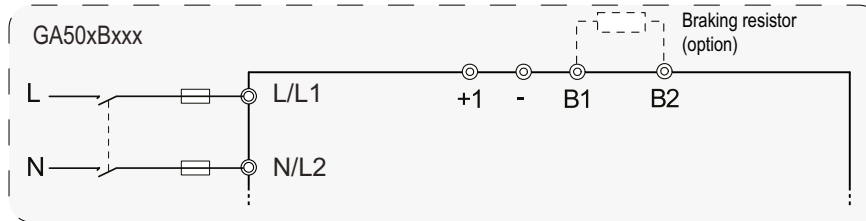

Three-phase  
200 - 400 V  
power supply,  
50/60 Hz

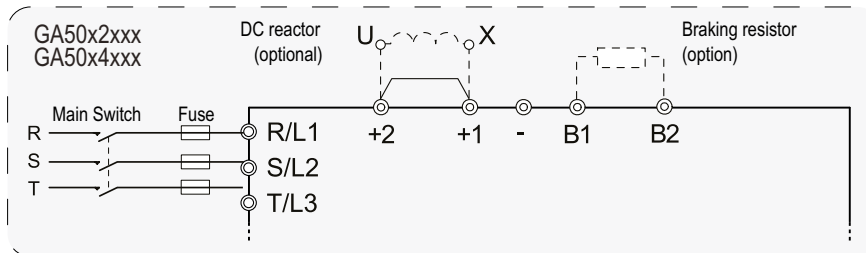

Multi-Function  
Digital Input  
(Default Setting)

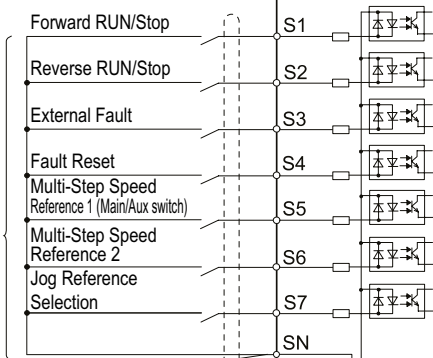

DC 24 V Power supply  
Output 24 V,  
max. 150 mA



Frequency  
Bias

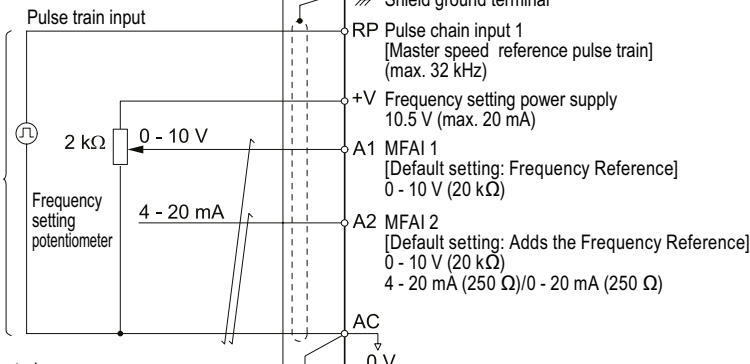

DC 24 V Control  
Power Input  
24 V 700 mA



MEMOBUS  
RS-485  
Max. 115 kbit/s

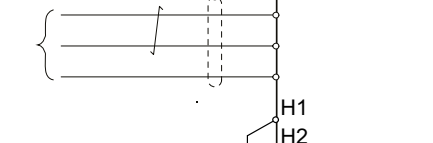

Safety Inputs  
(STO SIL3)

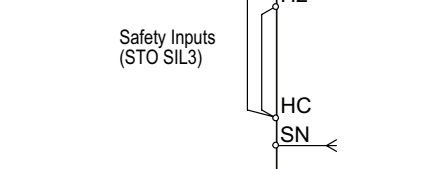

Drive

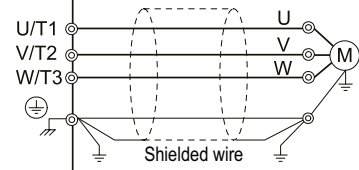
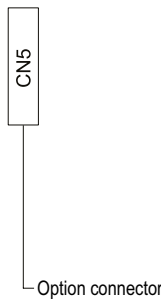

MA Fault Relay Output:  
AC 250 V, max. 1 A  
DC 30 V, max. 1 A  
(min. load DC 5 V, 10 mA)

P1 Multi-Function Photocoupler Output 1:  
DC 48 V, max. 50 mA  
[Default setting: During run]  
P2 Multi-Function Photocoupler Output 2:  
DC 48 V, max. 50 mA  
[Default setting: Frequency (Speed) Agree 1]

MP Pulse train output:  
0 - 32 kHz (2 kΩ)  
[Default setting: Output frequency]

AM Multi-Function Analog Monitor Output  
0 - 10 V/4 - 20 mA (250 Ω)  
[Default setting: Output frequency]

- ⊕ indicates shielded cable
- ⊗ indicates shielded twisted-pair cable
- ⊙ indicates main circuit terminal
- indicates control circuit terminal

# Technical Data

## Model Code

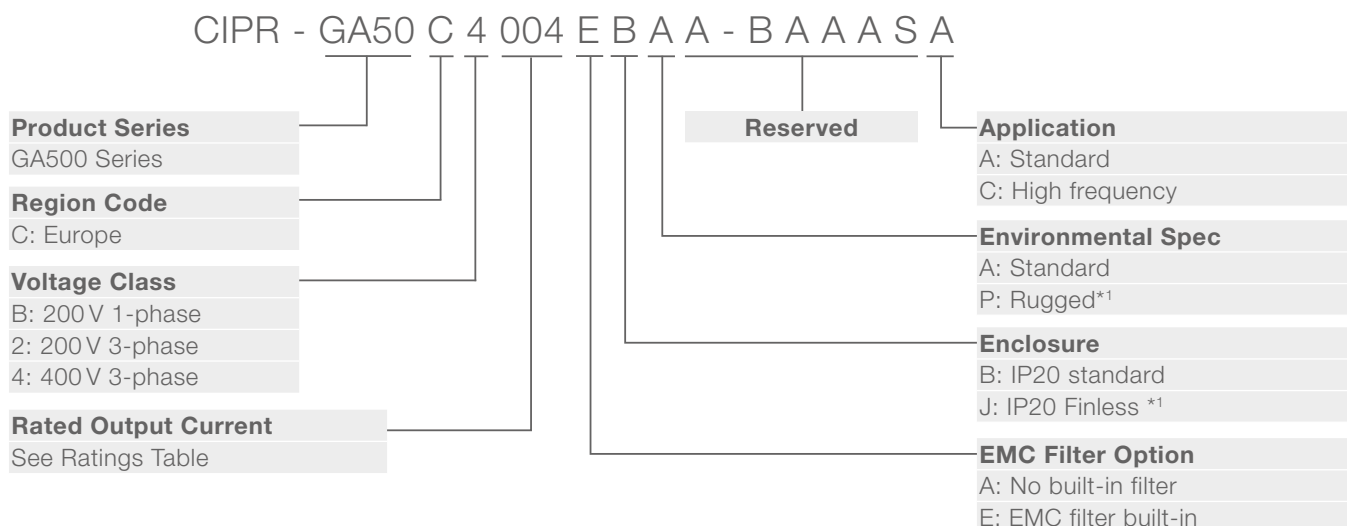

## IP20 standard | Ratings

Model Code GA50CxxxxEBAA	Max Appl. Motor Power	Rated Output Current	Dimensions [mm]				Weight [kg]	
	HD / ND [kW]	HD / ND [A]	W	H	D (no EMC filter) * <sup>2</sup>	D (with EMC filter) * <sup>3</sup>	(no EMC filter) * <sup>2</sup>	(with EMC filter) * <sup>3</sup>
<b>200 - 240 VAC, 1-phase</b>								
<b>B001</b>	0.1 / 0.18	0.8 / 1.2	68	128	76	116	0.5	0.7
<b>B002</b>	0.25 / 0.37	1.6 / 1.9					0.5	0.7
<b>B004</b>	0.55 / 0.75	3 / 3.5	68	128	118	158	0.8	1
<b>B006</b>	1.1 / 1.1	5 / 6	108	128	137.5	182.5	1.5	1.8
<b>B010</b>	1.5 / 2.2	8 / 9.6	108	128	154	199	1.5	1.8
<b>B012</b>	2.2 / 3.0	11 / 12.2	140	128	163	203	2.1	2.7
<b>B018</b>	4.0 / -	17.6 / -	170	128	180	-	2.9	-

\*<sup>1</sup> Available only without built-in EMC filter.

\*<sup>2</sup> Drive catalog code GA50CxxxxABAA.

\*<sup>3</sup> Drive catalog code GA50CxxxxEBAA.



## IP20 standard | Ratings

Model Code GA50CxxxxEBAA	Max Appl. Motor Power	Rated Out- put Current	Dimensions [mm]				Weight [kg]	
	HD / ND [kW]	HD / ND [A]	W	H	D (no EMC filter) *2	D (with EMC filter) *3	(no EMC filter) *2	(with EMC filter) *3
<b>200 - 240 VAC, 3-phase</b>								
2001	0.1 / 0.18	0.8 / 1.2	68	128	76	116	0.5	0.6
2002	0.25 / 0.37	1.6 / 1.9					0.5	0.6
2004	0.55 / 0.75	3 / 3.5	68	128	108	148	0.8	0.9
2006	1.1 / 1.1	5 / 6	68	128	128	168	0.9	1.1
2008	1.1 / 1.5	6.9 / 8	108	128	129	174	1.5	1.6
2010	1.5 / 2.2	8 / 9.6	108	128	129	174	1.5	1.6
2012	2.2 / 3.0	11 / 12.2	108	128	137.5	182.5	1.5	1.6
2018	3.0 / 3.7	14 / 17.5	140	128	143	193	2	2.4
2021	4.0 / 5.5	17.6 / 21	140	128	143	193	2	2.4
2030	5.5 / 7.5	25 / 30	140	260	140	196	3.4	3.9
2042	7.5 / 11	33 / 42					3.6	4.1
2056	11 / 15	47 / 56	180	300	143	196	5.5	6
2070	15 / 18.5	60 / 70	220	350	187	216	7.5	8.5
2082	18.5 / 22	75 / 82					8	9
<b>380 - 480 VAC, 3-phase</b>								
4001	0.37 / 0.37	1.2 / 1.2	108	128	81	126	0.8	1.4
4002	0.55 / 0.75	1.8 / 2.1			99	144	0.9	1.5
4004	1.1 / 1.5	3.4 / 4.1	108	128	137.5	182.5	1.5	1.9
4005	1.5 / 2.2	4.8 / 5.4	108	128	154	199	1.5	1.9
4007	2.2 / 3.0	5.6 / 7.1					1.5	1.9
4009	3.0 / 4.0	7.3 / 8.9					1.5	1.9
4012	4.0 / 5.5	9.2 / 11.9	140	128	143	193	2	2.6
4018	5.5 / 7.5	14.8 / 17.5	140	260	140	196	3	3.9
4023	7.5 / 11	18 / 23.4					3.2	3.9
4031	11 / 15	24 / 31	180	300	143	196	4.6	5.5
4038	15 / 18.5	31 / 38					4.8	5.5
4044	18.5 / 22	39 / 44	190	350	204	251	6.5	8
4060	22 / 30	45 / 60					6.5	8.5

# Technical Data

## IP20 Finless | Ratings

Model Code GA50CxxxxAJAA	Max Appl.Motor Power HD / ND [kW]	Rated Output Current HD / ND [A]	Dimensions [mm]			Weight [kg]
			W	H	D	
<b>200 - 240 VAC, 1-phase</b>						
B001	0.1 / 0.18	0.8 / 1.2	68	128	71	0.6
B002	0.25 / 0.37	1.6 / 1.9				0.6
B004	0.55 / 0.75	3 / 3.5	68	128	81	0.6
B006	1.1 / 1.1	5 / 6	108	128	81	0.9
B010	1.5 / 2.2	8 / 9.6	108	128	92.5	1.0
B012	2.2 / 3.0	11 / 12.2	140	128	98	1.2
<b>200 - 240 VAC, 3-phase</b>						
2001	0.1 / 0.18	0.8 / 1.2	68	128	71	0.6
2002	0.25 / 0.37	1.6 / 1.9				0.6
2004	0.55 / 0.75	3 / 3.5	68	128	71	0.6
2006	1.1 / 1.1	5 / 6				0.6
2008	1.1 / 1.5	6.9 / 8	108	128	72.5	0.8
2010	1.5 / 2.2	8 / 9.6				0.8
2012	2.2 / 3.0	11 / 12.2	108	128	81	0.9
2018	3.0 / 3.7	14 / 17.5	140	128	78	1.2
2021	4.0 / 5.5	17.6 / 21				1.2
2030	5.5 / 7.5	25 / 30	140	260	145	2.9
2042	7.5 / 11	33 / 42				3.1
2056	11 / 15	47 / 56	180	300	147	4.5
2070	15 / 18.5	60 / 70	220	350	152	6.0
<b>380 - 480 VAC, 3-phase</b>						
4001	0.37 / 0.37	1.2 / 1.2	108	128	75	0.8
4002	0.55 / 0.75	1.8 / 2.1				0.8
4004	1.1 / 1.5	3.4 / 4.1	108	128	83.5	0.9
4005	1.5 / 2.2	4.8 / 5.4	108	128	100	1.0
4007	2.2 / 3.0	5.6 / 7.1				1.0
4009	3.0 / 4.0	7.3 / 8.9				1.0
4012	4.0 / 5.5	9.2 / 11.9	140	128	78	1.2
4018	5.5 / 7.5	14.8 / 17.5	140	260	145	2.6
4023	7.5 / 11	18 / 23.4				2.8
4031	11 / 15	24 / 31	180	300	147	4.1
4038	15 / 18.5	31 / 38				4.3

# Accessories

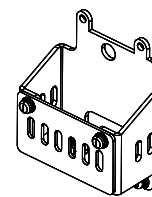
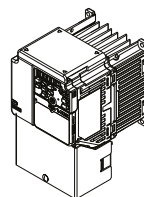
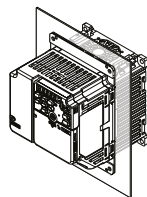
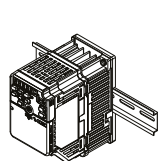

Drive Model GA50CxxxABAA	DIN Rail Attachment Model *1	External Heatsink Mounting Kit *2	UL Type 1 Kit *3	Shield Clamp Kit *3
<b>200 - 240 VAC, 1-phase</b>				
<b>B001, B002</b>	ZPZ-GA50V1	ZPSA-GA50V1-1	ZBAA-GA50V1-1	ZHZ-GA50V1
<b>B004</b>	ZPZ-GA50V1	ZPSA-GA50V1-2	ZBAA-GA50V1-2	ZHZ-GA50V1
<b>B006</b>	ZPZ-GA50V2	ZPSA-GA50V2-2	ZBAA-GA50V2-1	ZHZ-GA50V2
<b>B010</b>	ZPZ-GA50V2	ZPSA-GA50V2-3	ZBAA-GA50V2-2	ZHZ-GA50V2
<b>B012</b>	ZPZ-GA50V3	ZPSA-GA50V3-1	ZBAA-GA50V3-1	ZHZ-GA50V3
<b>B018</b>	EZZ08122D	ZPSA-GA50V4-1	ZBAA-GA50V4-1	ZHZ-GA50V4
<b>200 - 240 VAC, 3-phase</b>				
<b>2001, 2002</b>	ZPZ-GA50V1	ZPSA-GA50V1-1	ZBAA-GA50V1-1	ZHZ-GA50V1
<b>2004</b>	ZPZ-GA50V1	ZPSA-GA50V1-2	ZBAA-GA50V1-1	ZHZ-GA50V1
<b>2006</b>	ZPZ-GA50V1	ZPSA-GA50V1-3	ZBAA-GA50V1-1	ZHZ-GA50V1
<b>2008, 2010</b>	ZPZ-GA50V2	ZPSA-GA50V2-3	ZBAA-GA50V2-3	ZHZ-GA50V2
<b>2012</b>	ZPZ-GA50V2	ZPSA-GA50V2-3	ZBAA-GA50V2-1	ZHZ-GA50V2
<b>2018, 2021</b>	ZPZ-GA50V3	ZPSA-GA50V3-1	ZBAA-GA50V3-2	ZHZ-GA50V3
<b>2030, 2042</b>	-	ZPSA-GA50V5-1	ZBAA-GA50V5-1	ZHZ-GA50V5
<b>2056</b>	-	ZPSA-GA50V6-1	ZBAA-GA50V6-1	ZHZ-GA50V6
<b>2070, 2082</b>	-	ZPSA-GA50V7-1	ZBAA-GA50V7-1	ZHZ-GA50V7
<b>380 - 480 VAC, 3-phase</b>				
<b>4001</b>	ZPZ-GA50V2	ZPSA-GA50V2-1	ZBAA-GA50V2-4	ZHZ-GA50V2
<b>4002</b>	ZPZ-GA50V2	ZPSA-GA50V2-2	ZBAA-GA50V2-4	ZHZ-GA50V2
<b>4004</b>	ZPZ-GA50V2	ZPSA-GA50V2-2	ZBAA-GA50V2-5	ZHZ-GA50V2
<b>4005, 4007, 4009</b>	ZPZ-GA50V2	ZPSA-GA50V2-3	ZBAA-GA50V2-2	ZHZ-GA50V2
<b>4012</b>	ZPZ-GA50V3	ZPSA-GA50V3-1	ZBAA-GA50V3-2	ZHZ-GA50V3
<b>4018, 4023</b>	-	ZPSA-GA50V5-1	ZBAA-GA50V5-1	ZHZ-GA50V5
<b>4031, 4038</b>	-	ZPSA-GA50V6-1	ZBAA-GA50V6-1	ZHZ-GA50V6
<b>4044, 4060</b>	-	ZPSA-GA50V8-1	ZBAA-GA50V8-1	ZHZ-GA50V8

## Option Card Mounting Kit

JOHB-GA500

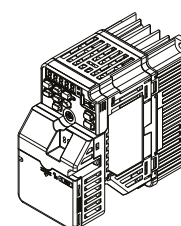

\*1 DIN rail attachment model not available for GA500 finless type GA50CxxxJBAA.

\*2 External heatsink mounting kit not available for GA500 finless type GA50CxxxJBAA.

\*3 UL Type 1 kit not compatible with shield clamp kit.

**YASKAWA Europe GmbH**

Philipp-Reis-Str. 6  
65795 Hattersheim am Main  
Germany

+49 6196 569-500  
support@yaskawa.eu  
www.yaskawa.eu.com

07/2023  
YEU\_INV\_GA500\_EN\_v4

Specifications are subject to change without notice for ongoing product modifications and improvements. © YASKAWA Europe GmbH. All rights reserved.

**YASKAWA**